

Article number: 0110047

Description: Retaining ring JS 30x1,5  
Springsteel

## Measures

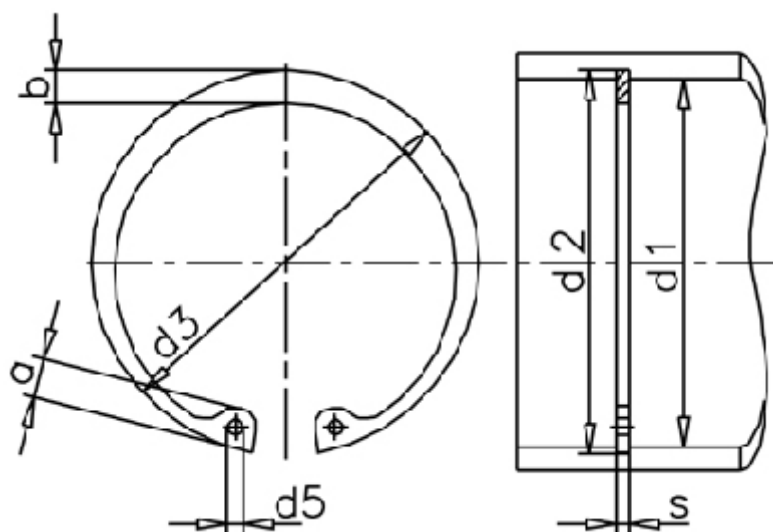

a max	= 5.5	Description	= JS 30	t	= 0.70
AN mm <sup>2</sup>	= 67	FN kN	= 11.3	tol	= 0.25
B	= 1.56	FRg kN	= 7.2	tol	= +0,50 -0,25
b	= 3.3	FR kN	= 21.4	tol	= -0.06
d1	= 30	g	= 1.0	Tong	= ZGJ-2
d2	= 31.4	m min	= 1.60	Weight kg/1000	= 2.7
d3	= 32.1	Nominal drive	= 2.1		
d5 min	= 2.0	s	= 1.50		